

**„Relieving pain and increasing  
well-being-using  
medical devices  
MADE IN GERMANY“**



**Made in Germany**



## OUR COMPANY

### Quality products - made in Germany

At Schneider Medical GmbH, our core business is producing and selling gel and powder products for cold and warm application. In particular, this involves reusable compresses, one-time instant compresses, orthopedic bandages and bottle coolers for use in the fields of medicine, wellness, sport and the household. In addition, we operate our production in an environmentally friendly manner with our own large-surface photovoltaic system.

Schneider Medical GmbH is Headquartered in Rheinau a town in southwest Baden-Württemberg, Germany which belongs to the Eurodistrict Strasbourg-Ortenau. Situated in the northern Black Forest at the eastern edge of the Upper Rhine Valley. Approximately 11km from the Eurocity Strasbourg and 130km from the pharma capital Basel, Switzerland.



### Versions

Our customers include major well-known, internationally operating medical product wholesalers as well as:

- ✓ pharmacies
- ✓ licensed physicians
- ✓ medical product retailers
- ✓ drug stores and health shops
- ✓ physiotherapists
- ✓ emergency services
- ✓ hospitals
- ✓ SMEs
- ✓ delivery services
- ✓ retirement and nursing homes
- ✓ transportation
- ✓ mobile care services



We are a family-managed firm that now has a fascinating 30-year history. What distinguishes our family? Our cohesion, values and traditions, but definitely our plans and visions as well. We are not solely a manufacturer and supplier, but a genuine partner. With a feeling of responsibility for long-term successful relationships.

The company sells products and services under its own brand names: Flexxum®, BodyPal®, Kuddler®, Seijos®, BottlePal® and CoolPack®. Furthermore, we produce numerous white label products under the manufacturer's brand for well-known internationally-operating wholesalers in the medical product sector.





# OUR PRODUCTS

REUSABLE COMPRESSES



WHITE LABEL

ONE-TIME INSTANT COMPRESSES



WHITE LABEL

ORTHOPEDIC BANDAGES



WHITE LABEL

HEAT PADS



WHITE LABEL

REUSABLE CHEST COMPRESSES



WHITE LABEL

COOLPACK



WHITE LABEL

## Our customer pledge - our name stands for this:



### Non Toxic – High Quality Gel

Quality gel maximum environmental friendliness & food-safe



### Five-year durability guarantee

for all of our products



### Easy-To-Use

Heating from deep-frozen condition possible



### Surround seal technology

Unique high recyclability, temperature resistance & safety



### Maximum safety benefit

Welded all-round and tested up to 300 kg pressure



### Pro-clean guarantee

Easy to clean and disinfect





# REUSABLE COMPRESSES FOR WARM AND COLD TREATMENTS

## Product description

Our vacuum-packed quality gel remains pliable down to -25°C – our special polymer film tolerates temperatures down to -50° C. The gel is available from us in glacier blue, transparent / colorless, or when bought in larger quantities, in the color of your choice. Our gel naturally also always remains pliable when deep frozen, down to -25°C.

## Why Flexxum Gel Packs?

- Very reusable, lowest cost per treatment
- Wide range of sizes, tiny to large
- Flexible when frozen (-25C), adapts to round body well
- Non Toxic
- Surround-seal technology for long lasting products tested up to 300kg pressure
- Easy cleaning and disinfection
- Air-free for efficient transfer of heat and cold to the body

## Versions

Reusable compresses (for warm and cold treatments)

- Flexxum®
- White Label

## Application Areas



Household



Medicine



Sports



WHITE LABEL





# REUSABLE COMPRESSES FOR WARM AND COLD TREATMENTS

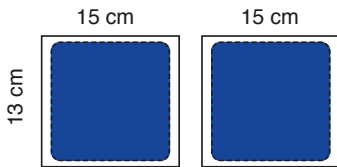

**Art. Nr. 040** 2 Pack per box  
12 boxes per case

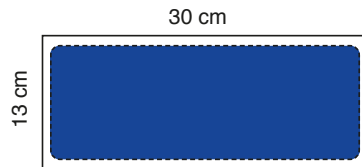

**Art. Nr. 041** 1 Pack per box  
12 boxes per case

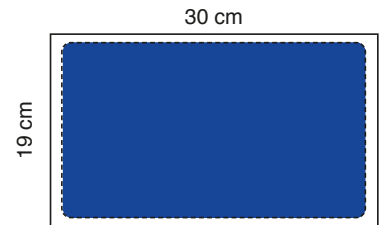

**Art. Nr. 043** 1 Pack per box  
6 boxes per case

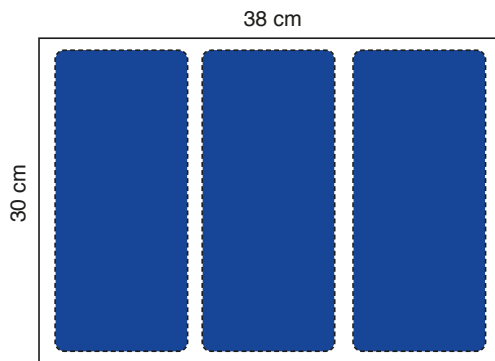

**Art. Nr. 044** 1 Pack per box  
5 boxes per case

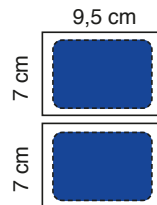

**Art. Nr. 049**  
2 Pack per box  
12 boxes per case

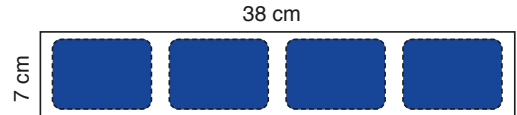

**Art. Nr. 045** 1 Pack per box  
12 boxes per case

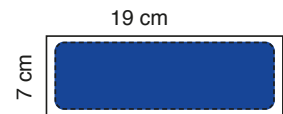

**Art. Nr. 053**  
1 Pack per box  
12 boxes per case

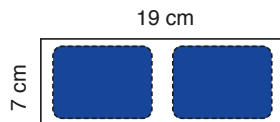

**Art. Nr. 047**  
1 Pack per box  
12 boxes per case

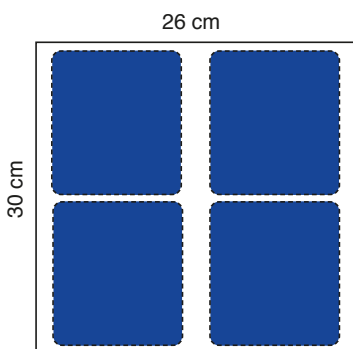

**Art. Nr. 048** 1 Pack per box  
6 boxes per case

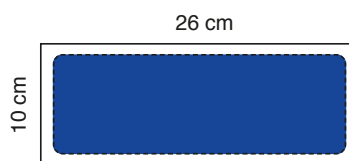

**Art. Nr. 066**  
1 Pack per box  
12 boxes per case

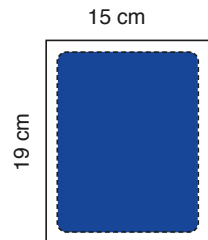

**Art. Nr. 052**  
1 Pack per box  
12 boxes per case

**FURTHER SIZES/FORMS ON REQUEST**

Gel available in 2 qualities :

- A: Gel flexible to -25 ° C, Polymer tolerates up to -50°C, transparent.
- B: Gel flexible to -12 ° C, Polymer tolerates up to -50°C, white or transparent.





# REUSABLE COMPRESSES FOR WARM AND COLD TREATMENTS

## Why FlexxumMat 051?

- Large gel mat 84x38cm
- Unique product worldwide
- Use for whole body or cut into sizes as needed eg. back or neck etc.
- Very interesting product for surgeons, ENT, physical therapists etc.
- Professional job satisfaction = realization of own ideas

### Usage:

- Small ones for fingers, hands, eyes, babies, small children, etc.
- Special shapes for back, neck, seat, surgery

## Professional usage

- Special shapes for back, neck, seat, surgery, etc.
- Childbirths: baby mat for newborns on childbirths
- Oncological treatments: underlayer for Leukapheresis & bone marrow puncture

Art. Nr. 051

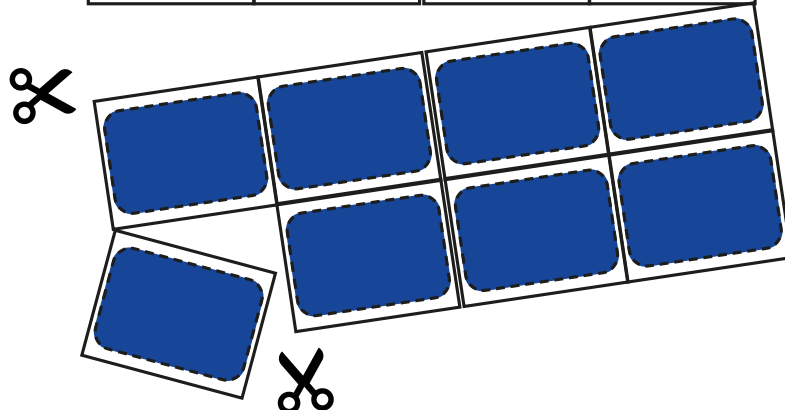
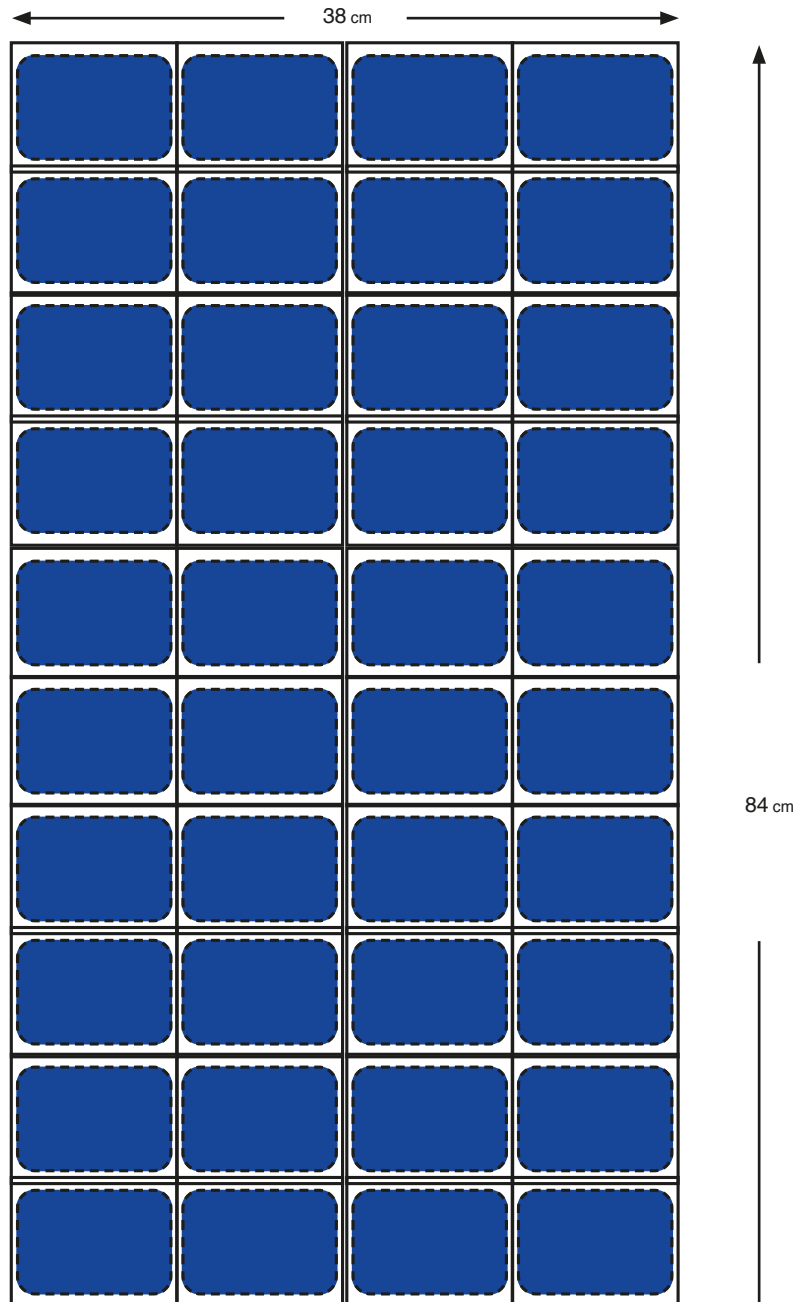
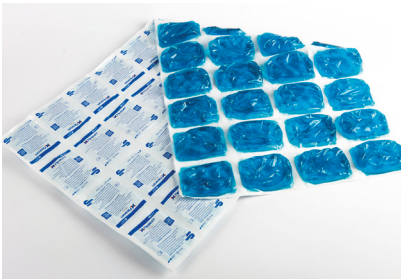

Largest size:  
38 x 84 cm

Smallest size:  
7 x 9,5 cm



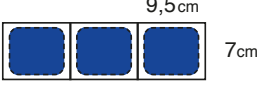
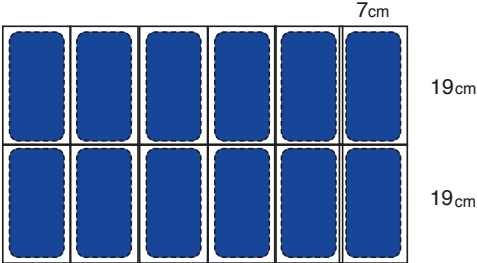
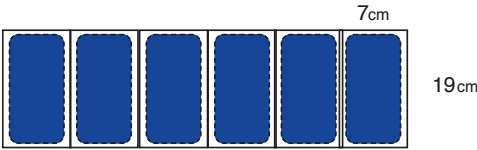

# REUSABLE COMPRESSES FOR WARM AND COLD TREATMENTS

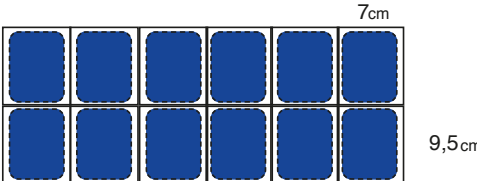
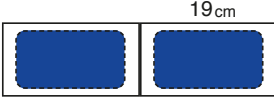
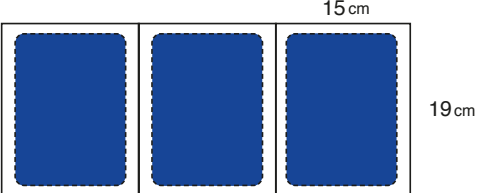
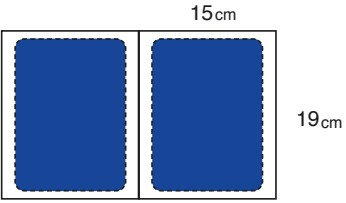
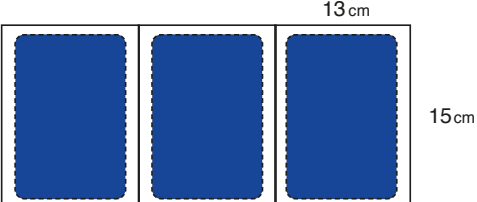
<b>Art. Nr. 046</b>	7 x 30 cm	
<b>Art. Nr. 050</b>	42 x 38 cm	
<b>Art. Nr. 054</b>	42 x 19 cm	
<b>Art. Nr. 055</b>	42 x 9,5 cm	
<b>Art. Nr. 056</b>	42 x 19 cm	
<b>Art. Nr. 057</b>	7 x 38 cm	
<b>Art. Nr. 058</b>	19 x 45 cm	
<b>Art. Nr. 046</b>	19 x 30 cm	
<b>Art. Nr. 060</b>	15 x 38 cm	





# REUSABLE COMPRESSES FOR WARM AND COLD TREATMENTS

Art. Nr. 061

30 x 38 cm

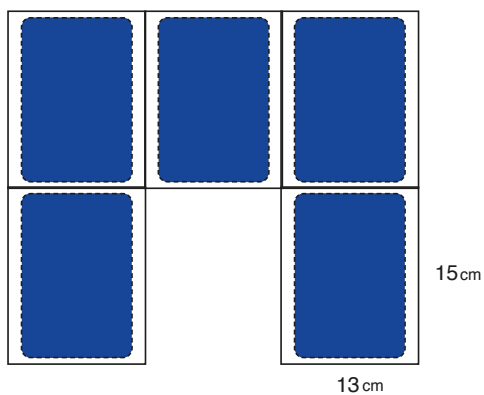

Art. Nr. 062

30 x 38 cm

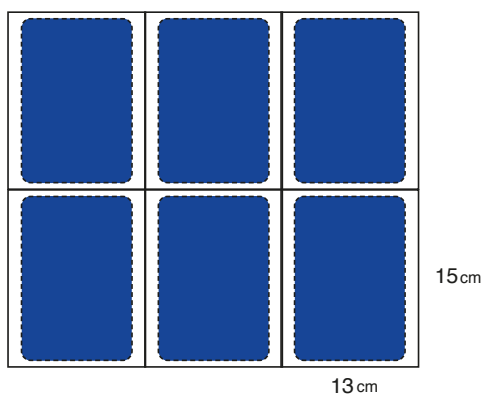

Art. Nr. 063

7 x 25 cm

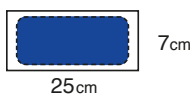

Art. Nr. 064

7 x 13 cm

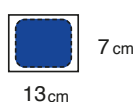

Art. Nr. 065

14 x 19 cm

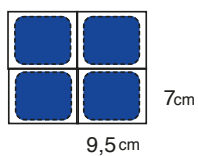

Art. Nr. 066

10 x 26 cm

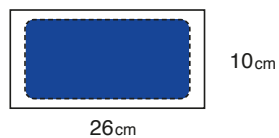

Art. Nr. 067

19 x 90 cm

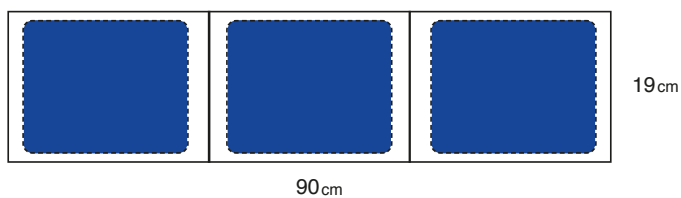





# REUSABLE COMPRESSES FOR WARM AND COLD TREATMENTS

**Art. Nr. 069**

10 x 13 cm



10 cm

13 cm

**Art. Nr. 070**

38 x 45 cm

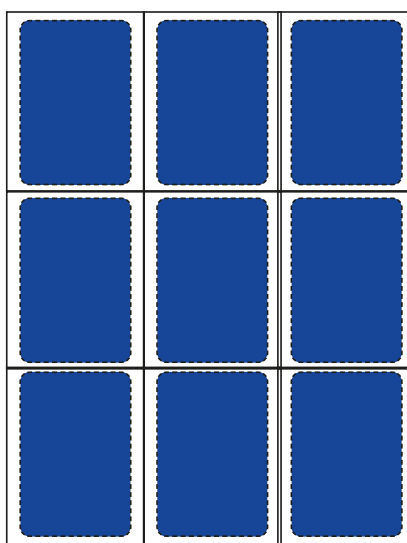

15 cm

13 cm

**Art. Nr. 071**

38 x 60 cm

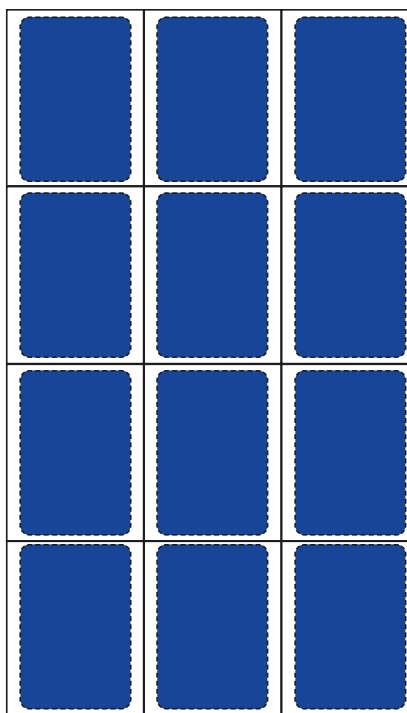

15 cm

13 cm





# REUSABLE COMPRESSES WITH VELCRO FASTENERS (FOR HOT AND COLD TREATMENTS)

## Product description

Our vacuum-packed quality gel remains pliable down to -25°C – our special polymer film tolerates temperatures down to -50° C. The gel is available from us in glacier blue, transparent / colorless, or when bought in larger quantities, in the color of your choice. Our gel naturally also always remains pliable when deep frozen, down to -25°C. Thanks to the Velcro, the BodyPal® is easy to attach.

## Why Flexxum BodyPal?

- Available in 5 Sizes (Hand, elbow, shin, ankle, knee, back)
- Flexible when frozen (-25C), adapts to round body well
- Non Toxic
- Surround-seal technology for long lasting products tested up to 300kg pressure
- Easy cleaning and disinfection
- Air-free for efficient transfer of heat & cold to the body

## Versions

- BodyPal®
- White Label

## Application Areas



Household



Medicine



Sports



WHITE LABEL





# REUSABLE COMPRESSES WITH VELCRO FASTENERS (FOR HOT AND COLD TREATMENTS)

Art. Nr. 080 **Xtra Small**

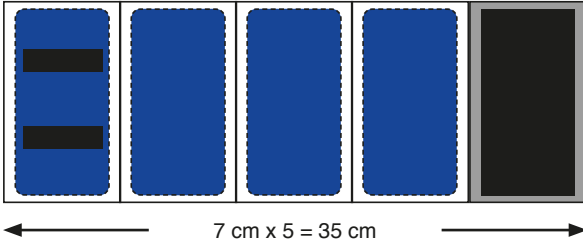

Art. Nr. 081 **Small**

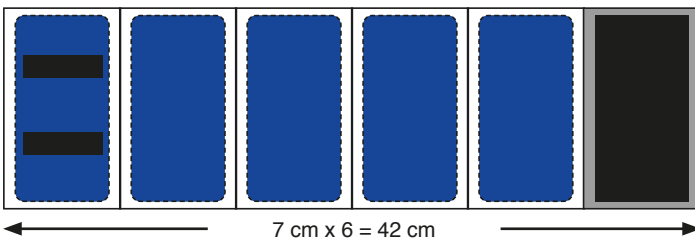

Art. Nr. 082 **Medium**

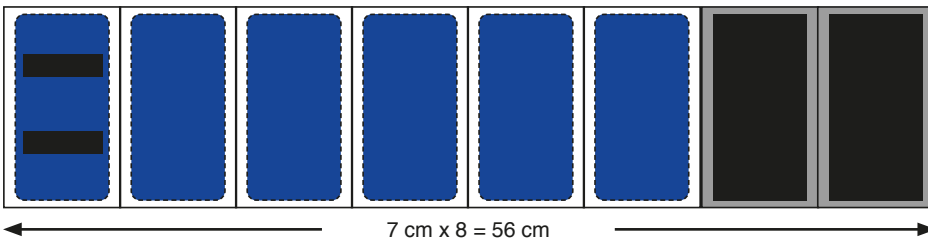

Art. Nr. 083 **Large**

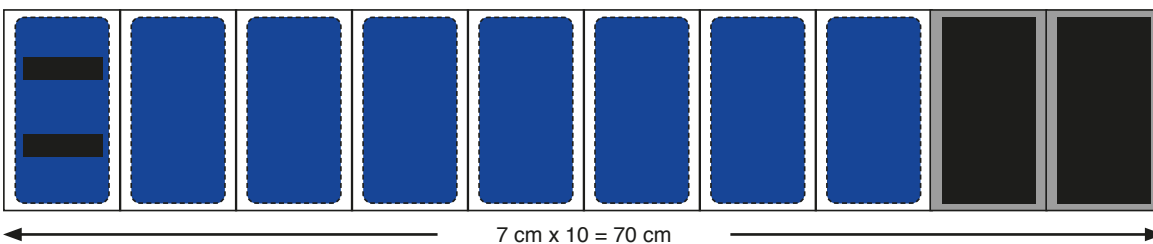

Art. Nr. 084 **Xtra Large**

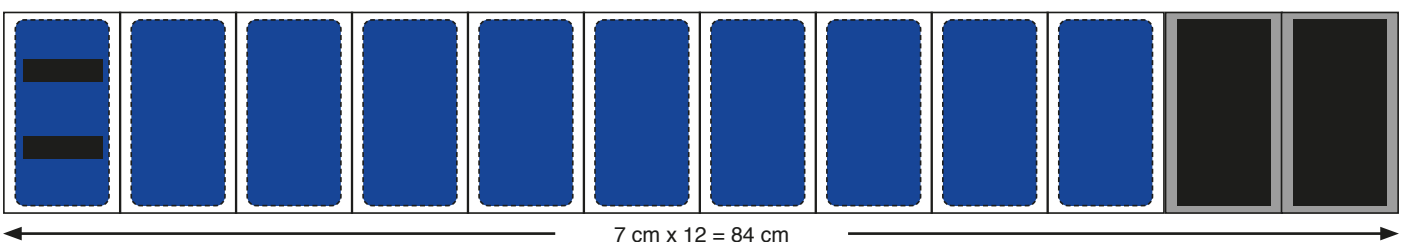

# ONE-TIME INSTANT COMPRESSES

## Product description

Our one-time instant compresses – warm (50°C) or cold (0°C) can be used for first aid. The packages are ready for treatment in just three simple steps and stay hot or cold for 20-30 minutes. The white cellulose coating lets the skin breathe at all times, while simultaneously stabilizing treatment temperatures.

## Why Flexxum Instant Packs?

- Available in different sizes
- No self-activation during transport
- Easy activation
- Surround-seal technology for long lasting products tested up to 300kg pressure
- Single instant use

## Versions

- Flexxum®
- White Label

## Application Areas



Household



Medicine



Sports



WHITE LABEL



# ONE-TIME INSTANT COMPRESSES

**Art. Nr. 001**

10 x 26 cm

**Art. Nr. 001B**

10 x 26 cm

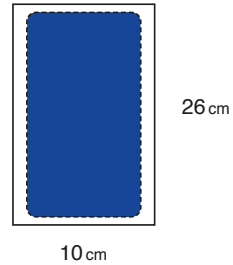

**Art. Nr. 004B**

10 x 13 cm

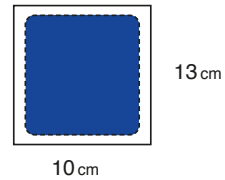

**Art. Nr. 005A**

13 x 15 cm

**Art. Nr. 005B**

13 x 15 cm

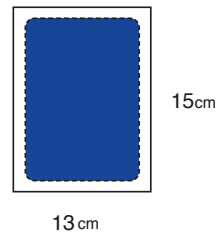

**Art. Nr. 015**

13 x 15 cm

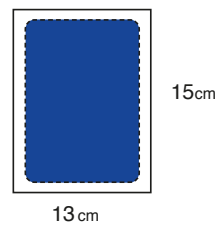

**Art. Nr. 002**

17 x 22 cm

**Art. Nr. 002B**

15 x 19 cm

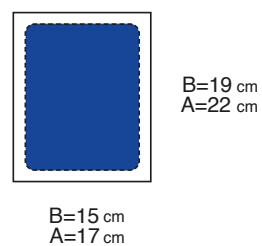



# HEAT PADS

## Product description

Our Kuddler® heat pads guarantee you pleasant, long-lasting heat relief over several hours. The insulating material cover is made of 100% cotton and is machine-washable, of course. Inside the cotton cover you find our suitable Flexxum®. Our heat pads can be heated both in the microwave as well as used with hot water.

## Why Kuddler heat pads?

- Modern warm or cooling cushions, insulated covers containing Flexxum Gel pack
- Heat in microwave, hot water or electric baking oven
- Cool in refrigerator or freezer
- Long lasting comfortable heating & cooling
- Easy mobility and efficient treatment
- Many applications due body fitting

## Versions

- Kuddler®
- White Label

## Application Areas



Household



Medicine



Sports



Gynecology



Hospital



Physiotherapy



WHITE LABEL

**WE  
WARM  
YOU.**



## Product description

Our CoolPack® straps replace cold poultices, ice cubes and hard cold compresses. They can be easily attached to the body and remain cold for a long time, due to the external insulation.

Our CoolPack® straps help in the event of accidents, and immediately and effectively reduce inflammation and swelling. Our CoolPack® are available for legs, knees, elbows, back, stomach and wrist / ankle.

Our covers are made of stretch material, machine-washable, insulated against cold loss and additionally protect against direct skin contact with cold. All of our Velcro fastenings are length-adjustable and can be used hundreds of times.

## Why Cool Pack?

- Cool against swelling and pain
- Warm for flexibility and against arthrosis
- Use for carpal tunnel syndrome & twisted ankle
- Available in 3 sizes (knee/ elbow), (wrist/ankle) & (hand/ thumb)

## Versions

- CoolPack®
- White Label

## Application Areas



Hospital



Physiotherapy



Sports



Household



Medicine



**WHITE LABEL**

**WE  
COOL  
YOU.**



# REUSABLE CHEST COMPRESSES

## Product description

Specially developed for natural pain treatment to the female body. For rapid, simple heat or cold pain therapy and complaints in the chest after operations or after nursing. Congestion, tense or sore breasts and incipient breast infections are the most common reasons why mothers stop breastfeeding. Our Seijos® chest pads relieve these symptoms by cooling or warming. Sensitive nipples remain free thanks to the opening. The warming application gently stimulates the natural flow of milk. After surgery-Seijos® chest pads quickly relieves pain. More comfort-Seijos® chest pads available with a soft protective cover.

## Why Seijos?

- Perfect for new mothers or after breast surgery
- Natural Pain treatment without medication
- Warm use for easier milk flow
- Cold use against swelling & pain
- Soft & light feeling
- Non toxic

## Versions

- Seijos®
- White Label

## Application Areas



Gynecology



WHITE LABEL





**Art. Nr. 028** BREAST PAD SEIJOS HOT/COLD, 8 compartments

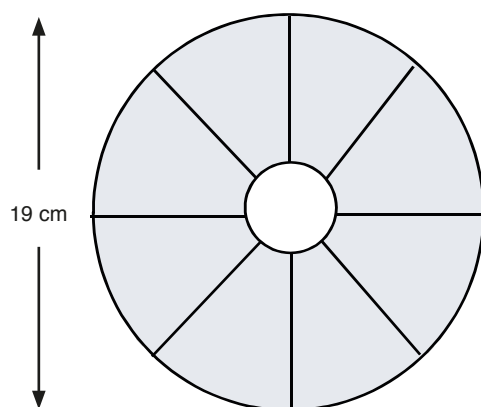

# ORTHOPEDIC BANDAGES

## Product description

Our elastic compression bandages are available for all standard application areas and as special major joint bandages. They are fast and easy to use, with the tried-and-tested Velcro-/adhesion system, strong and durable, washable and can be used as often as you want.

Our bandages can be washed at up to 40°C. The bandages are available in the popular colors white, beige, black, and other colors on request. All of our bandages are breathable and in addition keep the skin ideally dry by soaking up any sweat arising and releasing it outside.

## Why Flexxum bandages?

- Easy to use – self adhering closure
- Used as support or orthopaedic bandage, rib belt to hold electrodes in place
- Strong elasticity – without latex rubber
- Highly reusable – no loss of elasticity
- Machine washable
- Many sizes and widths available
- Easy and quick use saves time & costs

## Versions

- Flexxum®
- White Label

## Application Areas



Household



Medicine



Sports



Hospital



Physiotherapy



WHITE LABEL



# ORTHOPEDIC BANDAGES

**Art. Nr. 630**

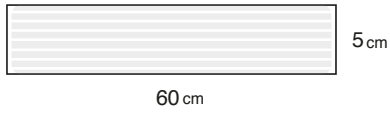

**Art. Nr. 631**

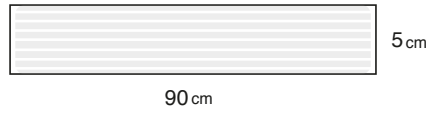

**Art. Nr. 530**

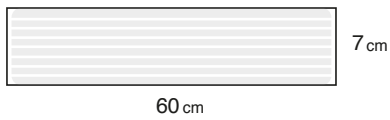

**Art. Nr. 531**

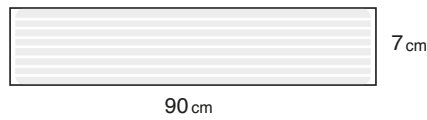

**Art. Nr. 533**

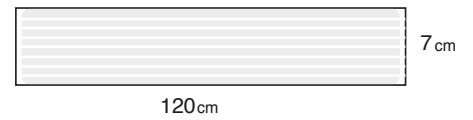

**Art. Nr. 653**

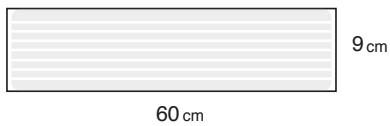

**Art. Nr. 673**

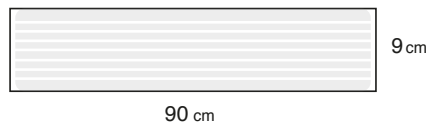

**Art. Nr. 693**

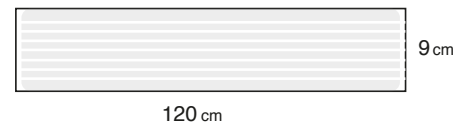

**Art. Nr. 553**

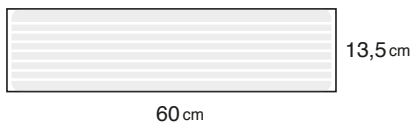

**Art. Nr. 573**

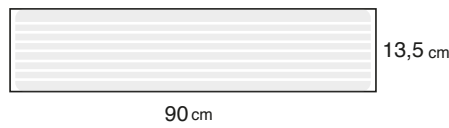

**Art. Nr. 593**

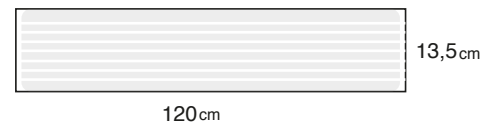

**Art. Nr. 454**

**Art. Nr. 455 (small)**

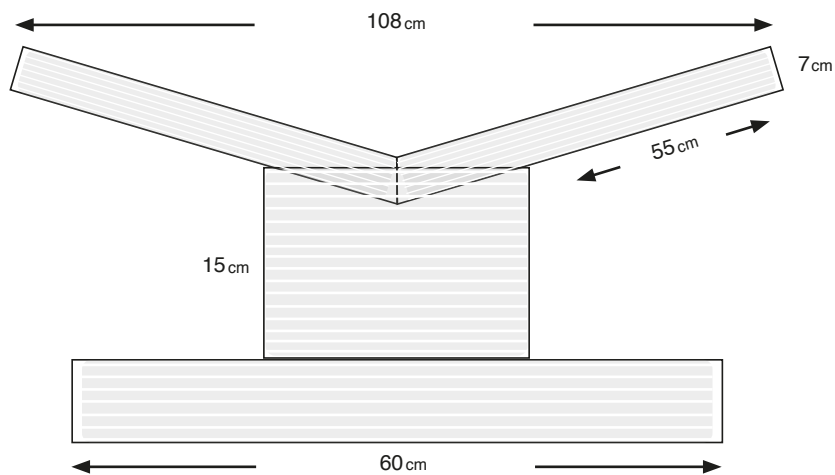

**Art. Nr. 830** 75 - 90 cm

**Art. Nr. 837** 92 - 110 cm

**Art. Nr. 844** 110 - 125 cm

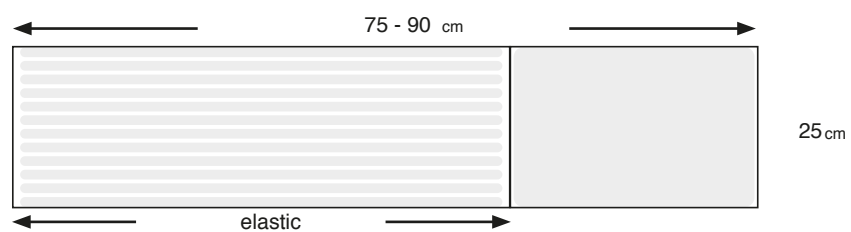

**WWW.SCHNEIDER-MEDICAL.COM**



**Made in Germany**



Schneider Medical GmbH  
Robert-Bosch-Str. 7  
D-77866 Rheinau

Tel.: +49 (0) 7844 7051  
Fax: +49 (0) 7844 4535  
E-Mail: [hello@schneider-medical.com](mailto:hello@schneider-medical.com)

Handelsregister  
Amtsgericht Freiburg i.Br.  
HRB 719590

Steuernummer  
14055/68475  
Ust.-ID DE322866601